

## **High Efficiency, 500KHz, 2.6A, 18V Input**

## **Synchronous Step Down Regulator**

### ❖ GENERAL DESCRIPTION

The AX3833 is a high efficiency 500 kHz synchronous step-down DC-DC converter capable of delivering 2.6A current. The AX3833 operates over a wide input voltage range from 4.5V to 18V and integrates main switch and synchronous switch with very low  $R_{DS(ON)}$  to minimize the conduction loss.

Low output voltage ripple and small external inductor and capacitor sizes are achieved with 500 kHz switching frequency. It adopts the instant PWM architecture to achieve fast transient responses for high step down applications.

### ❖ FEATURES

- Low  $R_{DS(ON)}$  for internal switches (top/bottom): 80mΩ/40mΩ
- 4.5-18V input voltage range
- 2.6A output current capability
- 500 kHz switching frequency
- Instant PWM architecture to achieve fast transient responses.
- Cycle-by-cycle peak current limitation
- Internal softstart limits the inrush current
- $\pm 1.5\%$  0.6V reference
- TSOT-23-6L package

#### **Applications**

- Set Top Box
- Portable TV
- Access Point Router
- DSL Modem
- LCD TV

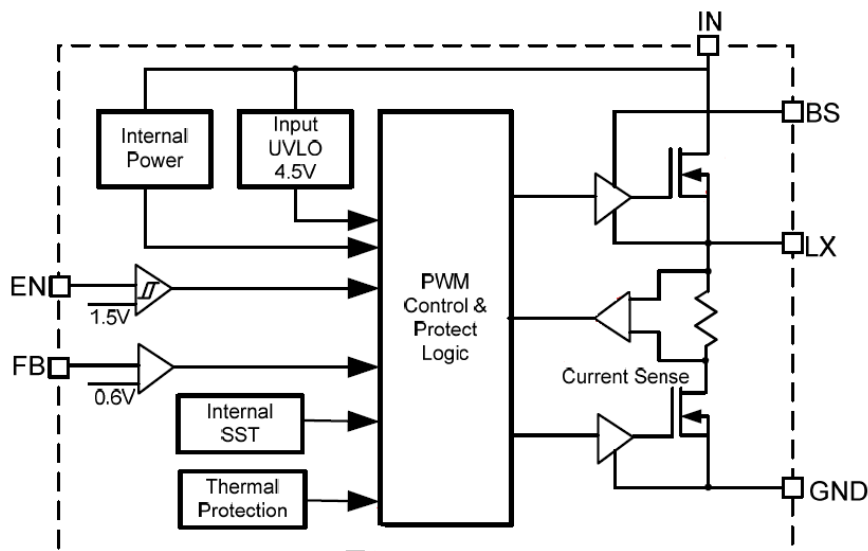
**❖ BLOCK DIAGRAM**

**❖ PIN ASSIGNMENT**

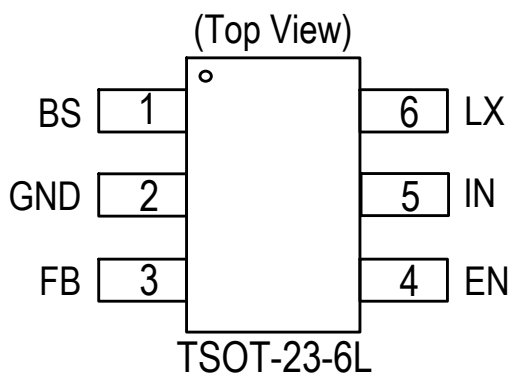
The package of AX3833 is TOST-23-6L; the pin assignment is given by:

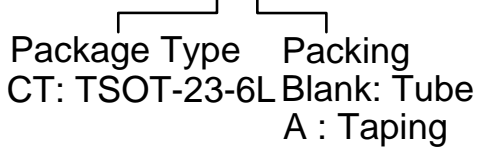
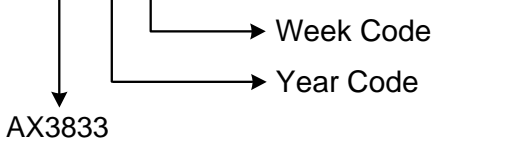

Name	Description
<b>BS</b>	Boot-Strap Pin. Supply high side gate driver. Decouple this pin to LX pin with 0.1uF ceramic cap.
<b>GND</b>	Ground pin
<b>FB</b>	Output Feedback Pin. Connect this pin to the center point of the output resistor divider (as shown in Figure 1) to program the output voltage: $V_{OUT}=0.6*(1+R1/R2)$
<b>EN</b>	Enable control. Pull high to turn on. Do not float.
<b>IN</b>	Input pin. Decouple this pin to GND pin with at least 1uF ceramic cap
<b>LX</b>	Inductor pin. Connect this pin to the switching node of inductor

### ❖ ORDER/MARKING INFORMATION

Order Information	Top Marking
<b>AX3833 XXX</b> 	<b>W C X Y Z</b> → Lot number Code  AX3833

### ❖ ABSOLUTE MAXIMUM RATINGS (at $T_A=25^{\circ}\text{C}$ )

Characteristics	Symbol	Rating	Unit
Supply Input Voltage	$V_{IN}$	19	V
Enable Voltage		$V_{IN}+0.3V$	V
FB Voltage		4	V
Power Dissipation	PD	1	W
Junction Temperature Range	$T_J$	150	$^{\circ}\text{C}$
Lead Temperature (Soldering, 10 sec.)		260	$^{\circ}\text{C}$
Storage Temperature Range		-65 to +150	$^{\circ}\text{C}$
Thermal Resistance from Junction to case	$\theta_{JC}$	11.2	$^{\circ}\text{C}/\text{W}$
Thermal Resistance from Junction to ambient	$\theta_{JA}$	100	$^{\circ}\text{C}/\text{W}$
<b>Recommended Operating Conditions (Note 3)</b>			
Supply Input Voltage		4.5 to 18	V
Junction Temperature Range		-40 to 125	$^{\circ}\text{C}$
Ambient Temperature Range		-40 to 85	$^{\circ}\text{C}$

**❖ ELECTRICAL CHARACTERISTICS**

 ( $V_{IN}=12V$ ,  $V_{OUT}=1.2V$ ,  $L=2.2\mu H$ ,  $C_{OUT}=47\mu F$ ,  $T_A=25^\circ C$ ,  $I_{OUT}=1A$  unless otherwise specified)

Characteristics	Symbol	Conditions	Min	Typ	Max	Units
Input Voltage Range	$V_{IN}$		4.5	-	18	V
Quiescent Current	$I_Q$	$I_{OUT}=0$ , $V_{FB}=V_{REF}*105\%$	-	100	-	$\mu A$
Shutdown Current	$I_{SHDN}$	EN=0	-	5	10	$\mu A$
Feedback Reference Voltage	$V_{REF}$		0.591	0.6	0.609	V
FB Input Current	$I_{FB}$	$V_{FB}=3.3V$	-50	-	50	nA
Top FET RON	$R_{DS(ON)1}$		-	80	90	m $\Omega$
Bottom FET RON	$R_{DS(ON)2}$		-	40	50	m $\Omega$
Top FET Peak Current Limit	$I_{LIM, TOP}$		-	-	6	A
Bottom FET Valley Current Limit	$I_{LIM}$		3	-	4.25	A
EN Rising Threshold	$V_{ENH}$		1.5	-	-	V
EN Falling Threshold	$V_{ENL}$		-	-	0.4	V
Input UVLO Threshold	$V_{UVLO}$		-	-	4.5	V
UVLO Hysteresis	$V_{HYS}$		-	0.3		V
Min ON Time			50	80	120	ns
Min OFF Time			140	170	220	ns
Switching Frequency			-	500	-	KHz
Soft-start Time	$t_{SS}$		-	800	-	$\mu s$
Thermal Shutdown Temperature	$T_{SD}$		-	150	-	$^\circ C$
Thermal Shutdown Hysteresis	$T_{HYS}$		-	15	-	$^\circ C$

Note 1: Stresses beyond the "Absolute Maximum Ratings" may cause permanent damage to the device. These are stress ratings only. Functional operation of the device at these or any other conditions beyond those indicated in the operational sections of the specification is not implied. Exposure to absolute maximum rating conditions for extended periods may affect device reliability.

Note 2:  $\theta_{JA}$  is measured in the natural convection at  $T_A = 25^\circ C$  on a low effective 4-layer thermal conductivity test board of JEDEC 51-3 thermal measurement standard. Pin2 of TSOT23-6 package is the case position for  $\theta_{JC}$  measurement.

Note 3: The device is not guaranteed to function outside its operating conditions

❖ APPLICATION CIRCUIT

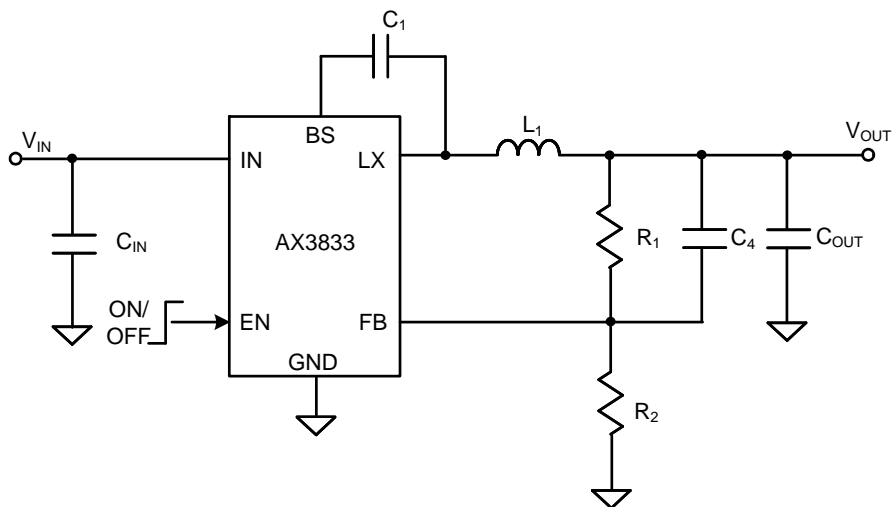

Figure 1. Schematic Diagram

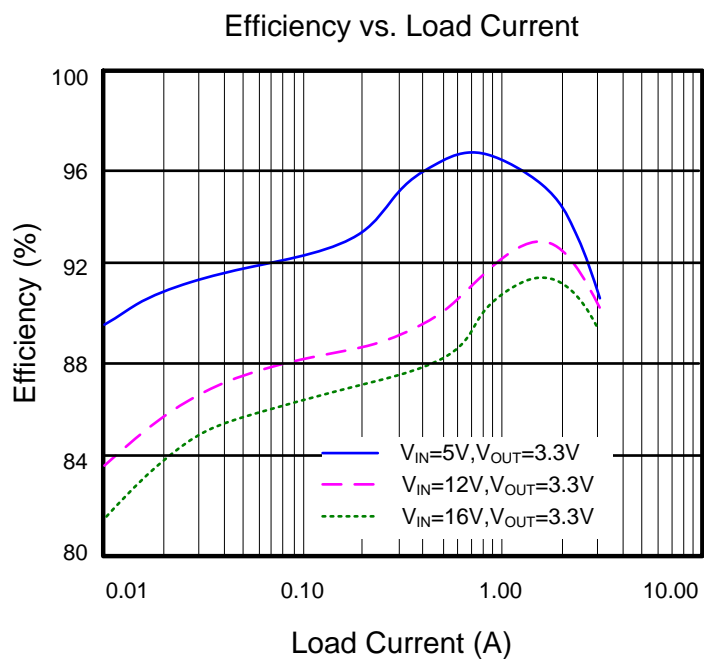

Figure 2. Efficiency Figure

## ❖ FUNCTION DESCRIPTIONS

### Operation

AX3833 is a synchronous buck regulator IC that integrates the PWM control, top and bottom switches on the same die to minimize the switching transition loss and conduction loss. With ultra-low  $R_{ds(on)}$  power switches and proprietary PWM control, this regulator IC can achieve the highest efficiency and the highest switch frequency simultaneously to minimize the external inductor and capacitor size, and thus achieving the minimum solution footprint.

AX3833 provides protection functions such as cycle by cycle current limiting and thermal shutdown protection. AX3833 will sense the output voltage conditions for the fault protection.

## ❖ APPLICATION INFORMATION

Because of the high integration in the AX3833 IC, the application circuit based on this regulator IC is rather simple. Only input capacitor  $C_{IN}$ , output capacitor  $C_{OUT}$ , output inductor L and feedback resistors ( $R_1$  and  $R_2$ ) need to be selected for the targeted applications specifications.

### Feedback resistor dividers $R_1$ and $R_2$ :

Choose  $R_1$  and  $R_2$  to program the proper output voltage. To minimize the power consumption under light loads, it is desirable to choose large resistance values for both  $R_1$  and  $R_2$ . A value of between  $10k\Omega$  and  $1M\Omega$  is highly recommended for both resistors. If  $V_{OUT}$  is 3.3V,  $R_1=100k$  is chosen, then using following equation,  $R_2$  can be calculated to be 22.1k:

$$R_2 = \frac{0.6}{V_{OUT} - 0.6} R_1$$

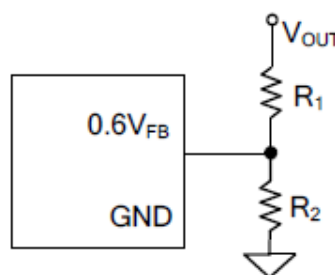

### Input capacitor $C_{IN}$

The ripple current through input capacitor is calculated as :

$$I_{CN\_RMS} = I_{OUT} \cdot \sqrt{D(1-D)}$$

To minimize the potential noise problem, place a typical X5R or better grade ceramic capacitor really close to the IN and GND pins. Care should be taken to minimize the loop area formed by CIN, and IN/GND pins. In this case, a 10uF low ESR ceramic capacitor is recommended.

### Output capacitor $C_{OUT}$

The output capacitor is selected to handle the output ripple noise requirements. Both steady state ripple and transient requirements must be taken into consideration when selecting this capacitor. For the best performance, it is recommended to use X5R or better grade ceramic capacitor greater than 22uF capacitance.

### Output inductor L

There are several considerations in choosing this inductor.

- (1) Choose the inductance to provide the desired ripple current. It is suggested to choose the ripple current to be about 40% of the maximum output current. The inductance is calculated as:

$$L = \frac{V_{OUT}(1 - V_{OUT}/V_{IN,MAX})}{f_{SW} \times I_{OUT,MAX} \times 40\%}$$

Where  $f_{sw}$  is the switching frequency and  $I_{OUT,MAX}$  is the maximum load current.

The AX3833 regulator IC is quite tolerant of different ripple current amplitude. Consequently, the final choice of inductance can be slightly off the calculation value without significantly impacting the performance.

- (2) The saturation current rating of the inductor must be selected to be greater than the peak inductor current under full load conditions.

$$I_{SAT,MIN} > I_{OUT,MAX} + \frac{V_{OUT}(1 - V_{OUT}/V_{IN,MAX})}{2 \cdot f_{SW} \cdot L}$$

- (3) The DCR of the inductor and the core loss at the switching frequency must be low enough to achieve the desired efficiency requirement. It is desirable to choose an inductor with  $DCR < 50m\Omega$  to achieve a good overall efficiency.

## External Bootstrap Cap

This capacitor provides the gate driver voltage for internal high side MOSEFET. A 100nF low ESR ceramic capacitor connected between BS pin and LX pin is recommended.

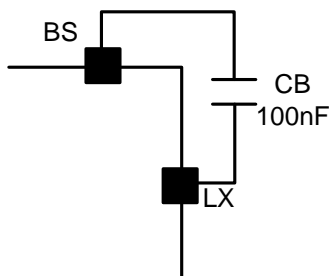

## Load Transient Considerations

The AX3833 regulator IC integrates the compensation components to achieve good stability and fast transient responses. In some applications, adding a 22pF ceramic cap in parallel with R1 may further speed up the load transient responses and is thus recommended for applications with large load transient step requirements.

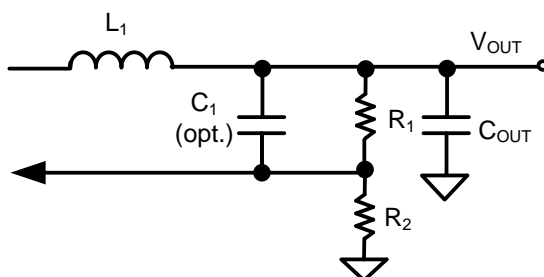

## Layout Design

The layout design of AX3833 regulator is relatively simple. For the best efficiency and minimum noise problem, we should place the following components close to the IC: CIN, L, R1 and R2.

- (1) It is desirable to maximize the PCB copper area connecting to GND pin to achieve the best thermal and noise performance. If the board space allowed, a ground plane is highly desirable.
- (2) CIN must be close to Pins IN and GND. The loop area formed by CIN and GND must be minimized.
- (3) The PCB copper area associated with LX pin must be minimized to avoid the potential noise problem.
- (4) The components R1 and R2, and the trace connecting to the FB pin must NOT be adjacent to the LX net on the PCB layout to avoid the noise problem.
- (5) If the system chip interfacing with the EN pin has a high impedance state at shutdown mode and the IN pin is connected directly to a power source such as a Li-Ion battery, it is desirable to add a pull down 1Mohm resistor between the EN and GND pins to prevent the noise from falsely turning on the regulator at shutdown mode.

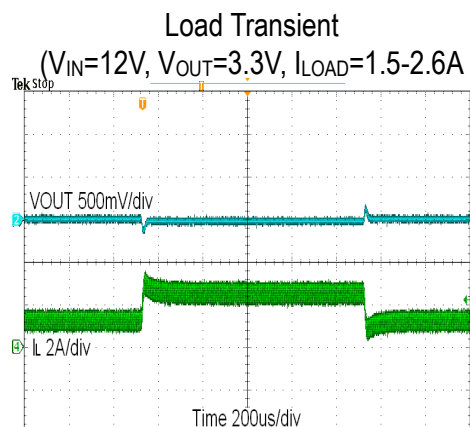
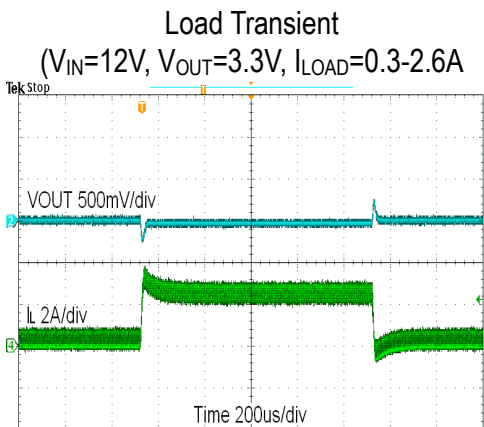
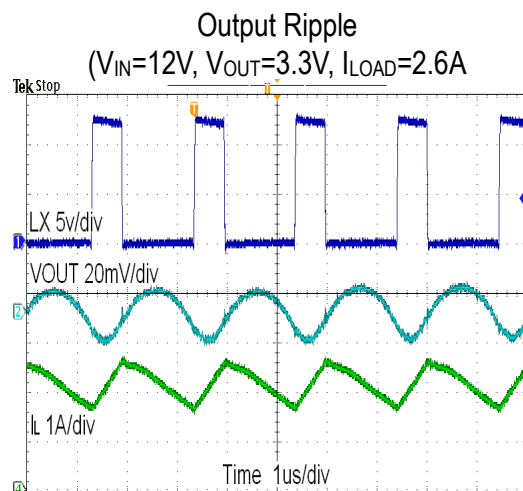
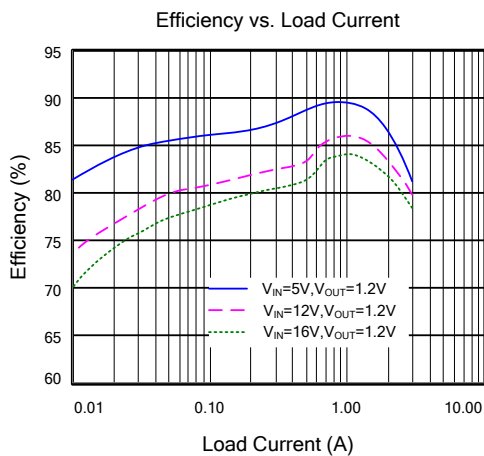
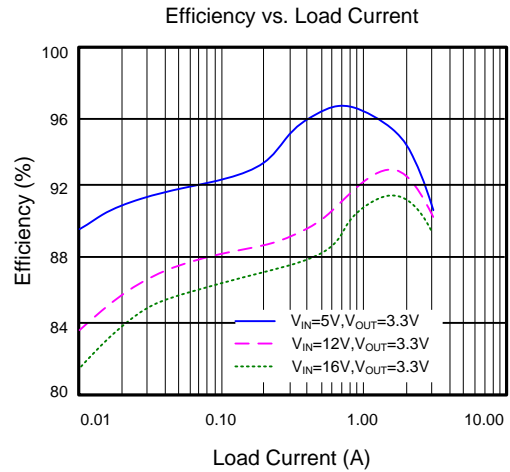
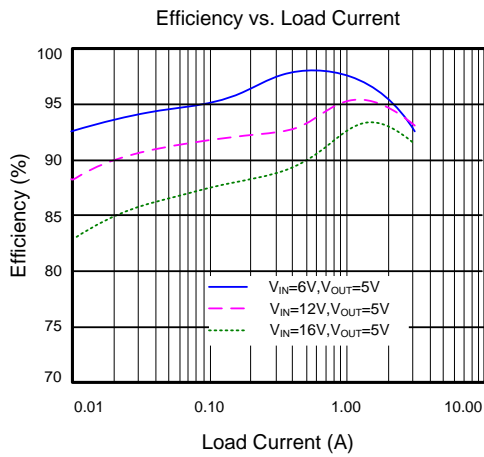

**❖ TYPICAL CHARACTERISTICS**

❖ TYPICAL CHARACTERISTICS

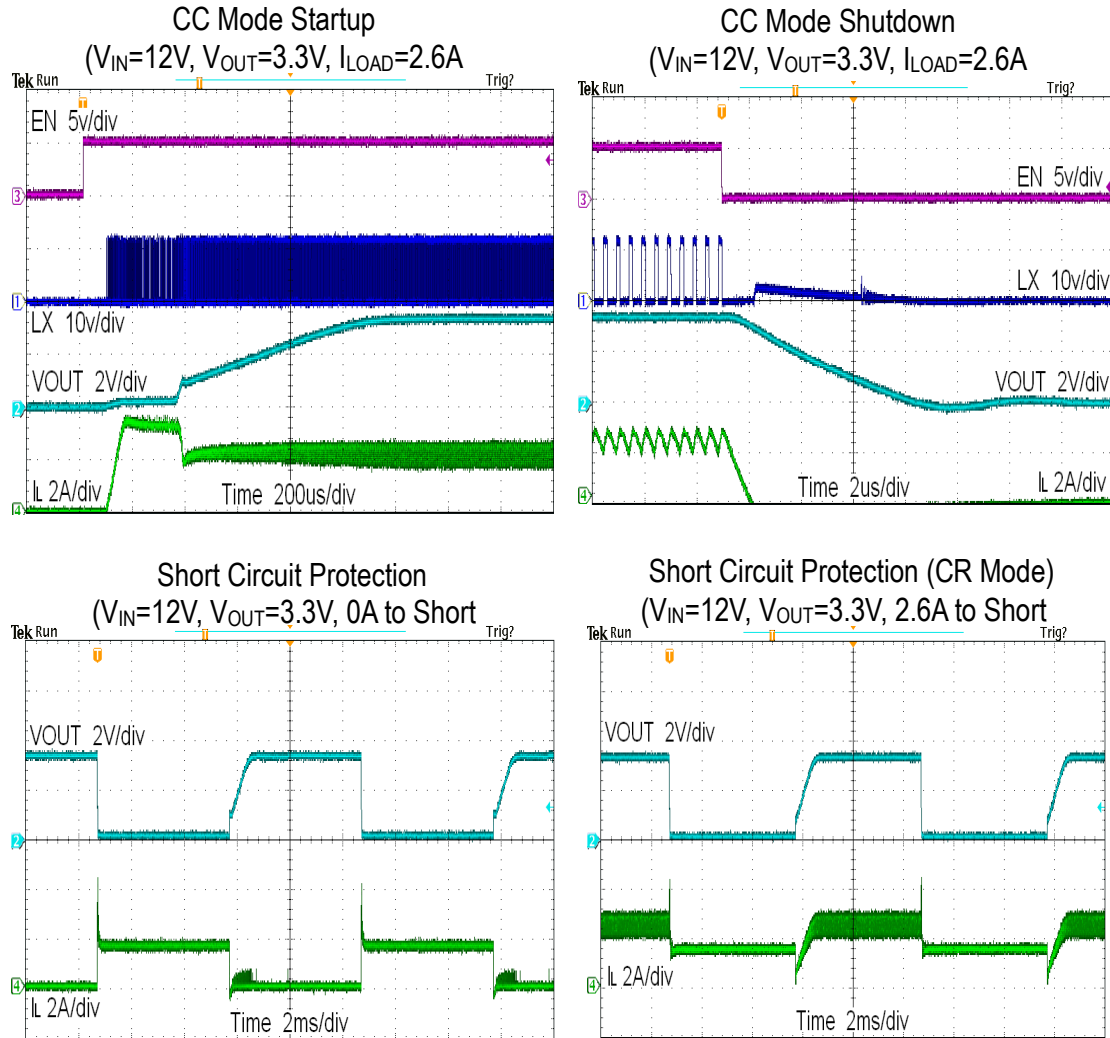

❖ PACKAGE OUTLINES

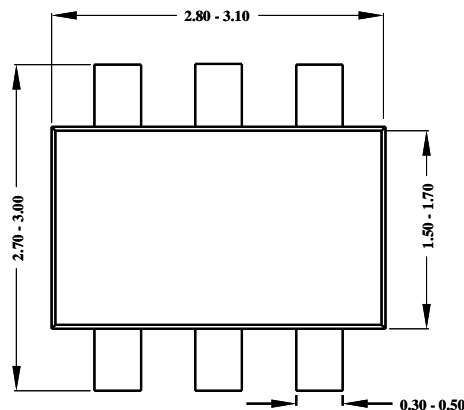
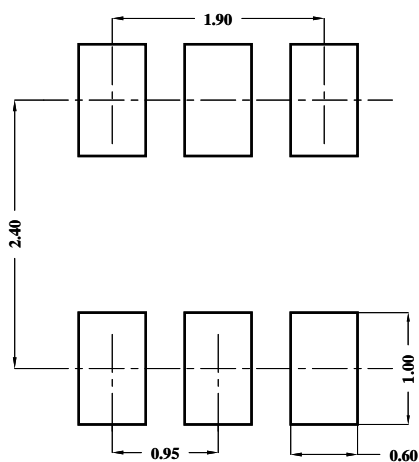

Recommended Pad Layout

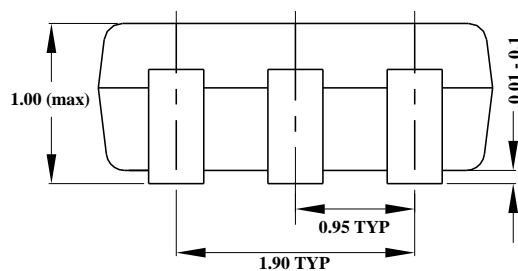
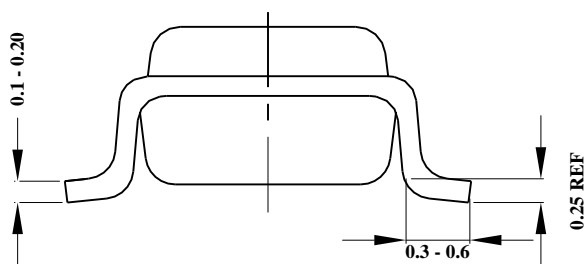

Notes:  
 All dimension in MM  
 All dimension don't not include mold flash and metal burr